

LOGGER S7021

Dual channel logger with counter and binary inputs

Instruction for use

Instruction for use of logger S7021

Logger is designed for monitoring and record of digital signals from external devices. It is equipped with input for pulse counting and binary input for record of time event. Signals are connected by means of the connector. Counter reading and actual state of binary input are displayed on dual line LCD are stored in adjustable interval to internal non-volatile memory. Input pulse signal is recalculated and displayed in real measured physical units by means of the PC software. All logger setting and control are done by means of the computer and can be protected by password. Logging start/stop is enabled: at certain time and date programmed from computer, by external signal connected to binary input or by delivered magnet). Switching ON and OFF is enabled also by external binary signal of channel 4.

It is also possible to operate logger with switched OFF display. Short display of actual measured values is enabled by means of magnet.

Switched ON logger every 10 s (independently on programmed logging interval) updates display reading, compares counter reading with two adjustable limits and indicates alarms on the display. Two alarm modes are enabled: instant or with memory (detected alarm is indicated permanently till alarm memory is cleared from the PC – useful if counter overflow is enabled). Alarm function can be enabled or disabled. Binary channel has no alarm function.

Counter can be configured as 16 bits (higher maximum number of recorded values) or 32 bits (higher counter range). Counter stops after filling the maximum value and logger is switched OFF with the message on the LCD. If needed counter mode can be selected, when after fulfilling counter overflows and continues from value 0.

Logging mode can be adjusted as non-cyclic, when logging stops after filling the memory. In cyclic mode oldest stored values are overwritten by new. In addition logging mode can be selected when logging is active only if measured value is out of adjusted alarm limits.

Stored values can be transferred from logger memory to the PC by means of communication adapter. Communication adapter can be connected to the logger permanently – data logging is not interrupted even if data download appears.

Logger evaluates minimum battery voltage and its drop below allowed limit is indicated on the display. At the same time value of remaining battery capacity is available by means of the PC program and appears on the logger LCD in % (every time after switch ON).

Technical parameters of the instrument:

Counter input (logger channel 1):

Counter range: in 16 bits mode 0 to 61 695 values

in 32 bits mode 0 to 2 021 654 527 values

Maximum counter value displayable on the LCD: 19999, 0 to 3 digits right from decimal point

Signal for counter input: from potential-less contact or binary voltage signal

Minimum pulse duration at counter input: 1 ms (shorter pulses may not be recorded)

Maximum frequency at binary input: 500 Hz

Current through closed contact: 30 μ A

Voltage across opened contact: 3.6 V

Low voltage level: 0 to +0.2 V (maximum current from input 30 μ A)

High voltage level: +3.0 to +30 V (maximum current to input 100 nA)

Incrementing of counter: by leading edge (by contact opening)

Binary input (logger channel 4):

Signal for binary input: from potential-less contact or binary voltage signal

Minimum pulse duration at binary input: 500 ms (shorter pulses may not be recorded)
 Maximum frequency at binary input: 0.5 Hz (i.e. maximum 5 pulses in 10 s)
 Current through closed contact: 3 μ A
 Voltage across opened contact: 3.6 V
 Low voltage level: 0 to +0.2 V (maximum current from input 3 μ A)
 High voltage level: +3.0 to +30 V (maximum current to input 100 nA)
 Built-in connector for input signals: male CANON 9 pins
 Cable for connection of input signals: shielded, maximum length 10 m
 Alarm evaluation interval and display refresh: 10 s
 Logging interval: 10 s to 24 h (20 steps)
 Memory capacity:

counter mode 16 bits:	non-cyclic logging mode	32 504 readings
	cyclic logging mode	28 896 readings
counter mode 32 bits:	non-cyclic logging mode	16 252 readings
	cyclic logging mode	15 296 readings

Specified values are maximum possible and can be reached only if record since last memory erasing was not interrupted and no event on binary inputs was recorded. Each event record on the binary input decreases above capacity of one record.
 Communication with computer: via RS232 (serial port) by means of COM adapter or USB port by means of USB adapter; data transfer from logger via communication adapter is optical
 Real time clock: adjustable from computer, integrated calendar including leap years
 Error of internal RTC: < 200 ppm (i.e. 0.02 %, 17.28 s in 24 h)
 Power: Lithium battery 3.6 V size AA
 Battery life:

- typical (data download to PC is carried out about once a week): 3 years
- in continuous on-line mode with interval 1 minute: approximately 2 years
- in continuous on-line mode with interval 10 seconds: approximately 1 year

Notice: The above battery lives are valid for logger operation in temperature from -5 to +35°C. If often operated outside of the above temperature range battery life can be reduced to 75%.
 Protection: IP67
 Operational conditions:

- Operational temperature range: -30 to +70 °C
- Operational humidity range: 0 to 100 %RH
- Specification of outer characteristics accordingly to EN33-2000-3: normal environment accordingly to appendix NM: AE1, AN1, AR1, BE1
- Operational position: negligible

Logger installation: by self adhesive Dual Lock, applied to clean, flat surface
 Not allowed manipulation: it is not allowed to operate instrument with not connected temperature probes - if all probes are not connected, unconnected connectors should be protected by included connector cover.
 Limit condition: temperature -40 to +70 °C, humidity 0 to 100 %RH
 Storing condition: temperature -40 to +85 °C, humidity 0 to 100 %RH
 Dimensions: 93 x 64 x 29 mm
 Weight including battery: approximately 120 g
 Material of the case: polycarbonate

Logger operation

Logger comes complete with installed battery and switched OFF. Before operation it is necessary by means of installed user PC software to set logging parameters and other features. The PC program is common for all types of loggers Sxxxx – **for type S7021 it is necessary to have installed version 1.10.9.0** or higher. Older program version can cause logger reconfiguration together with loss of proper function! Installed program version can be verified in menu *Help / About program...* Free newest program version is available to download at www.cometsystem.cz . For communication with the PC a communication adapter is necessary (not included in delivery). For connection via RS232 serial port it is necessary to use COM ADAPTER, for connection via USB port it is necessary to use USB ADAPTER. Connect adapter connector to proper computer port and plug the adapter to the guide slots on the side of logger.

Connecting logger to the computer by means of communication adapter

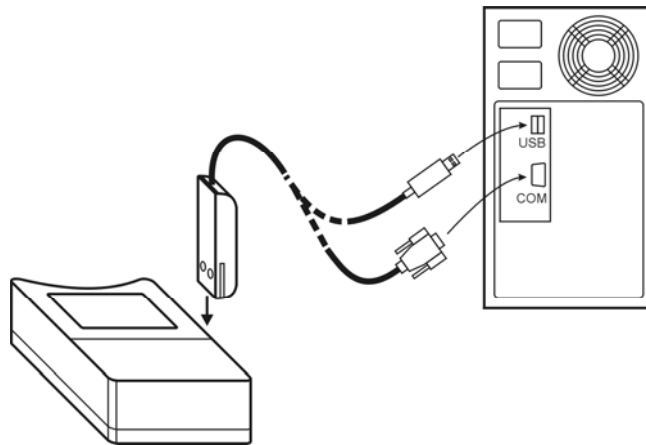

Notice: USB connector can be located also at the computer front side

After connecting the logger to the computer reading of logger info is enabled by means of the PC software and also setting of the instrument accordingly to the user needs (menu *Configuration / Setting of instrument parameters*). Before logging start it is necessary:

- check or optionally set the logger real time clock
- select suitable logging interval (it has no influence to binary inputs record)
- select logging mode (cyclic or non cyclic)
- set counter mode (16 or 32 bits)
- specify recalculation constants for counter (if counter reading should indicate directly the monitored physical value) and number of digits right from decimal point
- switch ON the binary input, if it should be recorded
- switch ON the logger (or switch OFF, if delayed start by magnet or automatic is required)
- enable or disable the option to switch ON the logger by magnet
- enable or disable the option to switch OFF the logger by magnet
- set date and time of logger automatic switching ON logger or disable this option
- optionally enable to control logging by external signal (i.e. logger switch ON/OFF is controlled by binary input state at channel 4). Set required binary state for switching ON the logger from the menu of channel 4 parameters.
- select if record runs permanently or only if alarm is active
- If alarms are about to be applied, set both limits and enable alarm (only for counter input)
- optionally enable permanent alarm indication (alarm with memory)
- switch ON or switch OFF the display of logger

- check free space in data memory, optionally erase data memory of the logger
- enter password if protection against unauthorized manipulation with the logger is necessary

Logging interval between to subsequent measurements is specified by the user. Memorizing of the first value is synchronized with the internal real time clock, so the logging is performed at sharp multiples of minutes, hours and days. E.g. after starting the logging with the 15 minute interval the first value is not stored immediately, but after the internal clock gets the status of a quarter, a half or a whole hour. After starting the logging with the 6 hours interval the first value is stored at that whole hour to perform the storing also at 00.00, i.e. at the beginning of the day. First storing is performed at 6.00, 12.00, 18.00 or 00.00hour - at the hour from the above nearest to the logging start. After communication with computer or after start by magnet logger automatically waits for the nearest whole multiple of time and then first measurement is performed. This is also necessary to take into account when setting time of automatic logger switch ON.

Notice: If logger operates as permanently connected to the computer, using of magnet start/stop is disabled.

To enable the logger control by magnet is suitable only in cases, when possibility of unauthorized manipulation to the logger operation is eliminated.

If logger is controled by external signal (i.e. by binary state at input 4), logger will be switched OFF (when programmed binary state at input 4 appears) with the delay up to 10 s!

User description of binary states is displayed only at the data list on the computer. On the logger LCD indication ON and OFF is displayed permanently.

Selection of „display of increments“ at the card of counter channel setting causes record of counter increments in time specified by logging interval. On the logger LCD counter values are displayed (not increments).

Logger connection to monitored devices

Connect logger to monitored device by shielded cable with 9 pins female CANON connector. If IP67 protection is required, it is necessary to use watertight connector (optional accessory). Channel 1 of the logger (IN1) works as counter at pin 6 of the connector, channel 4 works as binary input at pin 1 of the connector. Both inputs have common ground (GND) at connector pins 5 a 9. Those pins serve for connection of the cable shielding. As monitored signal use quality mechanical contact (reed contact) or device with „open collector“ or device with binary voltage output. Due to high input impedance it is necessary to avoid presence of increased electromagnetic interference (e.g. electric switchboards, motors, device containing power current switching elements - contactors, relays or pulse converters etc.).

If logger will be controlled (switch ON and OFF) by external binary signal, connect output of the control device to pin 1 (input 4 of the binary channel) and pin 5 (signal ground). It is necessary to allow selection „Logger control by external signal“. At the same time set required binary level for logger switch ON at the card of channel 4. In switching ON by external signal logger reacts immediately, in switching OFF reacts with delay of maximum 10 s.

Notice: pin 9 is galvanic connected to pin 5 (both GND). If other signal source is used than potential-less mechanical contact, note, that signal grounds of both channels will be connected together – grounds of both devices must be mutually galvanic isolated or must be at the same potential!

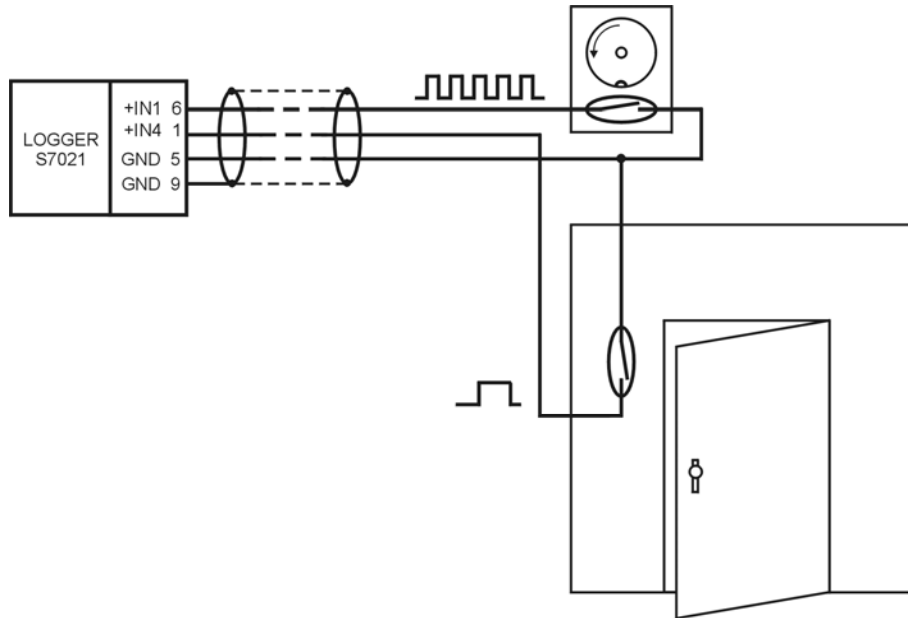

Other possibilities of logger connection to monitored device by means of optional accessory are described at the end of the manual.

Reading on the display in usual operation (logger switched ON)



After switching ON the instrument all symbols on the LCD are displayed for about 2 seconds.

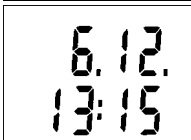

Then actual date and time in logger is displayed for about 4 s.

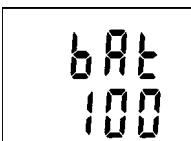

Consequently remaining battery capacity is displayed for about 2 s (value 0 to 100%). It is valid if logger is operated at temperature from -5 to +35°C. If logger is operated often outside of the above temperature range battery life can be reduced to 75%, i.e. if displayed remaining battery capacity drops below 25%, it is recommended to replace the battery.

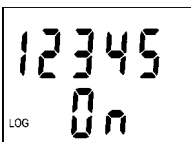

If LCD is switched ON, actual readings are displayed then – counter value on the upper line (with respecting of optional user recalculation to real input quantity). Lower line displays binary input actual state. Symbol On indicates closed contact (respectively low voltage level), symbol OFF indicates opened or not connected contact (respectively high voltage level). Symbol LOG indicates logging in progress – if it blinks, data memory is filled for more than 90%.

If counter value exceeds LCD 19999, symbol E and three lowest bits of counter value are displayed to inform on counter activity.

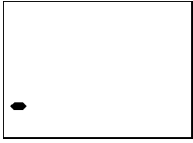
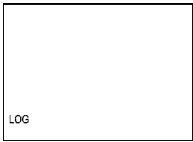

If LCD is switched OFF, after remaining battery capacity is displayed LCD switches OFF. Only symbol LOG is displayed if logger is switched ON. Symbol LOG blinks, if data memory is filled for more than 90%. If logger is operated with LCD switched OFF in the mode, when record works only if alarm is active, symbol LOG is replaced by the neighbor symbol – (hyphen). It appears in case, counter value is at set limits and logging is stopped. Displayed symbol indicates logger is switched ON.

If logger LCD is switched OFF, short display is enabled by the magnet (this is not possible if logger is operated with permanently connected communication adapter). Insert magnet to slots at the side of the logger and wait for about 4 seconds. If logger has enabled the function of switching OFF by magnet, do not remove magnet from slots before indication decimal point goes out – logger would be switched OFF! Display goes out automatically after 30 s. Remove magnet from slots anytime during display is ON or later.

Activation of switched OFF LCD for 30 seconds by the magnet

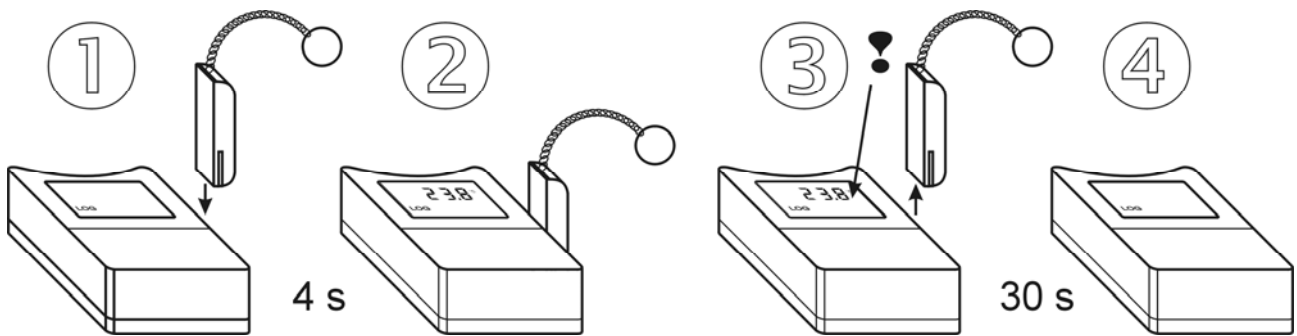

Alarm indication on the LCD

Allow alarm evaluation from the PC program and set lower and upper alarm limit of the counter input (binary input has no alarm function). If counter values are at range inside of the set limits, alarm is not active. If counter value exceeds any of set limits, alarm will be activated and indicated on the LCD. Alarm function has two modes: instant or with memory (detected alarm is indicated permanently till alarm memory is cleared from the PC (useful if counter overflow is enabled)).

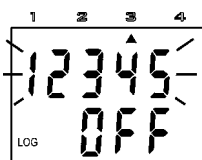

Active alarm is indicated (if LCD is ON) by blinking of the counter value on the LCD and by arrow 3 at the LCD upper side.

Notice: if logger is operated at low temperature (below approximately -5 °C), alarm indication by blinking can be indistinct. Indication by arrows works correctly.

Messages displayed on the LCD beyond usual operation

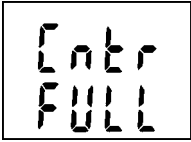

Cntr
FULL

If counter is totally full and counter „overflow“ is not enabled, logging stops and logger is switched OFF. Message Cntr FULL (counter full) appears on the LCD. It appears also if logger is operated with switched OFF display.

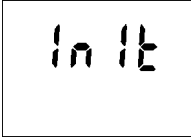

In It

New initialization of logger can occur in switching ON the logger (immediately after displaying of all LCD segments for checking) e.g. after replacement of totally discharged battery for new one. State is indicated by INIT reading. It can be displayed for about 12 s.

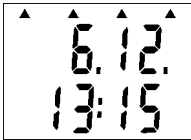

6.12.
13:15

If battery voltage drop occurred since last internal clock setting below critical limit or battery disconnection for longer period than approximately 30 s, after display switch ON (during date and time display) all four arrows appears as warning to check or set it again from the computer. However all logger functions work without limitation.

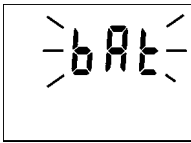

bAt

If reading BAT is displayed periodically on LCD upper line (for 1 s with 10 s interval), the end of estimated battery life is coming – however logger functions are not limited. Replace battery as soon as possible!

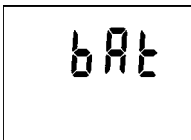

bAt

If reading BAT is displayed permanently, battery voltage is low and logger is not possible to switch ON. If logger was switched ON before it, data logging is stopped and logger is switched OFF. Communication with computer can temporarily work. Replace battery as soon as possible!

Start / stop by magnet

The function must be enabled from the PC before. If only switching OFF by magnet is enabled, it is of course necessary to switch ON the logger from the computer.

Switching the logger ON by magnet

Plug magnet to guide slots from logger front side and wait approximately 1 s for decimal point appears right on LCD upper line. After appearance it is necessary immediately (till indication point is displayed) to remove magnet from guide slots and logger switches ON.

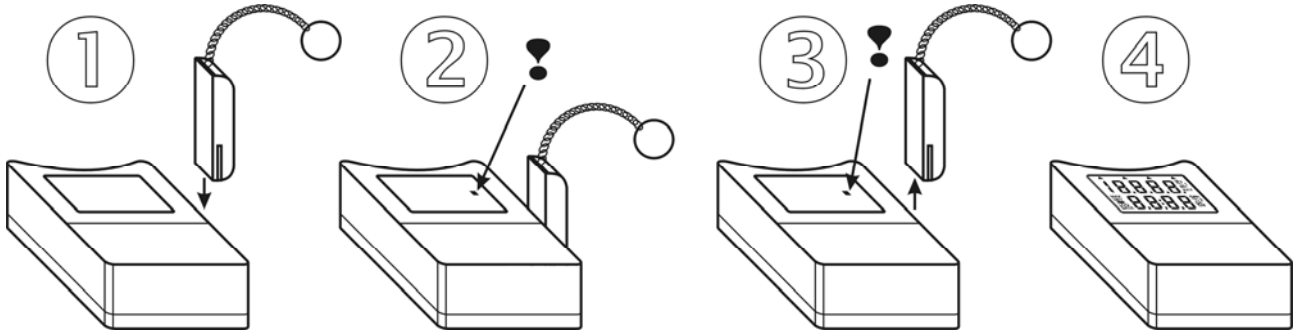

Switching the logger OFF by magnet

The procedure is identical with the above procedure for switching ON. If decimal point does not appear after 1 s, it is necessary remove the magnet and repeat the procedure.

Logger connection to monitored device by the K0945 adapter

If no protection against water is required, easy connection to monitored signals is enabled by the optional K0945 adapter. Insert adapter to logger connector and connect input signals to screw terminals of the adapter - see figure. Adapter has only IP20 protection, logger protection of IP67 is not possible to apply with the K0945 adapter.

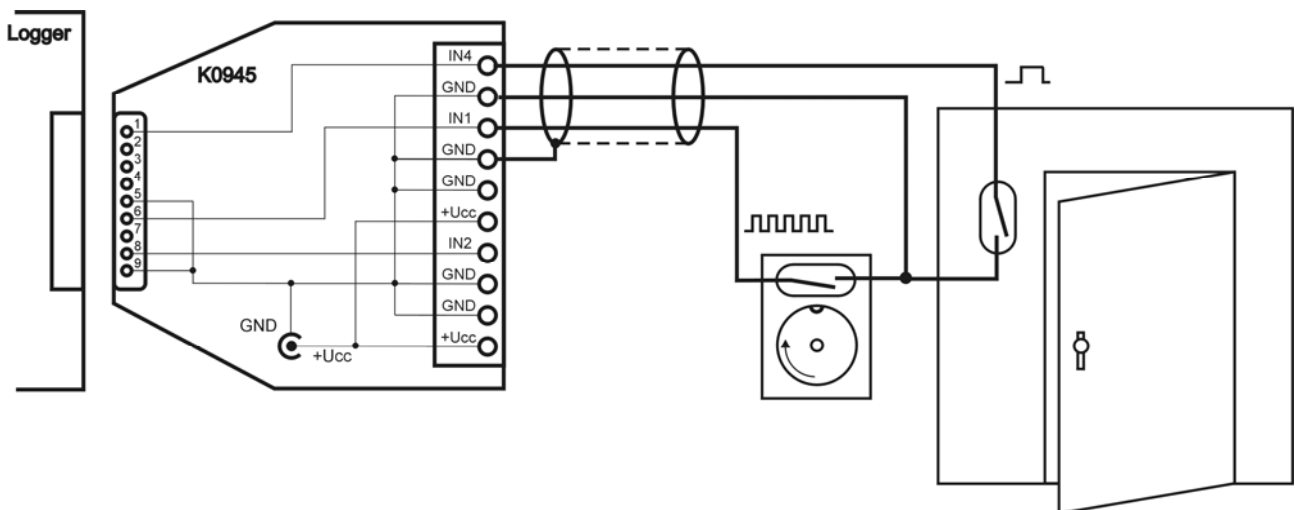

Let co-axial power connector of the K0945 adapter not connected, there is no need to supply the adapter. Monitored devices in the figure are only for illustration.

Battery replacement

Low battery is indicated on the display by blinking of reading "BAT". It can be displayed permanently, if battery voltage is too low. Replace the battery for new one. If logger is operated often in temperature below -5°C or over $+35^{\circ}\text{C}$ and PC program indicates remaining battery capacity below 25% it is also recommended to replace the battery. Applied is Lithium battery 3.6 V, size AA. Battery is located under logger lid.

Warning: near battery fragile glass reed contact is located – be careful not to damage it. Be careful in battery replacement!

Replacement procedure:

- switch off the logger by the PC program or by magnet (if low battery allows)
- unscrew four corner screws and remove the lid
- remove old battery by pulling the glued tape
- insert new battery **respecting the correct polarity** (see symbols + and – near battery holder). If you connect new battery up to 30 s, all logger settings remain unchanged. In the opposite case check by means of PC program all settings, especially the real time clock in logger. **Attention, inserted battery with incorrect polarity causes logger damage!**
- put the lid back again and screw four screws. Be careful to have the rubber sealing properly in the slot and tighten the screws properly to ensure the water resistance of the instrument.
- connect logger to the computer and **write to it the information on battery replacement** (menu Configuration/Battery replacement). This step is necessary to evaluate properly the remaining battery capacity.

Old battery or logger itself (after its life) is necessary to liquidate ecologically!

Instruments passed the following electromagnetic compatibility (EMC) tests:

radiation: EN 55022	class B
immunity: EN 61000-4-2	(levels 4/8 kV, class A)
EN 61000-4-3	(intensity of electromagnetic field 3 V/m, class A)
EN 61000-4-4	only types with external probes (levels 1/0,5 kV, class A)
EN 61000-4-6	only types with external probes (intensity of electromagnetic field 3 V/m, class A)